

CONTROL PLATE

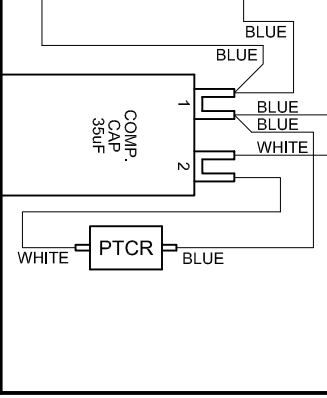
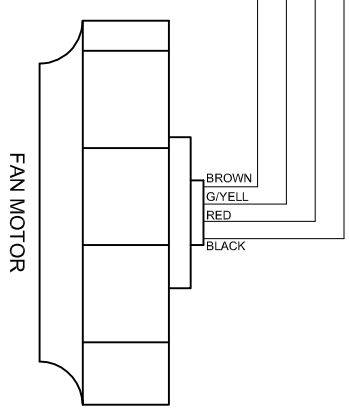
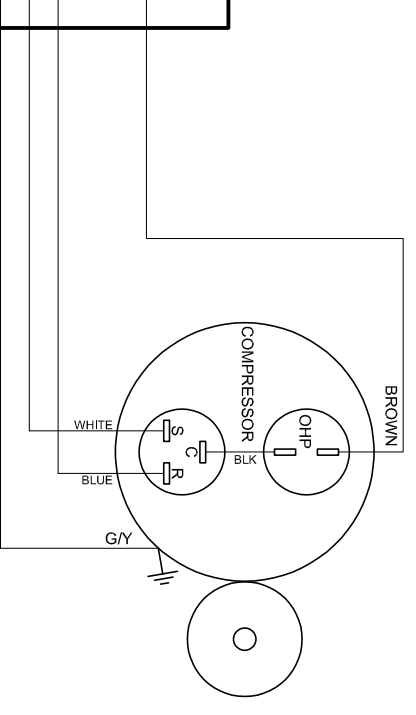
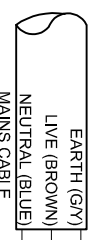
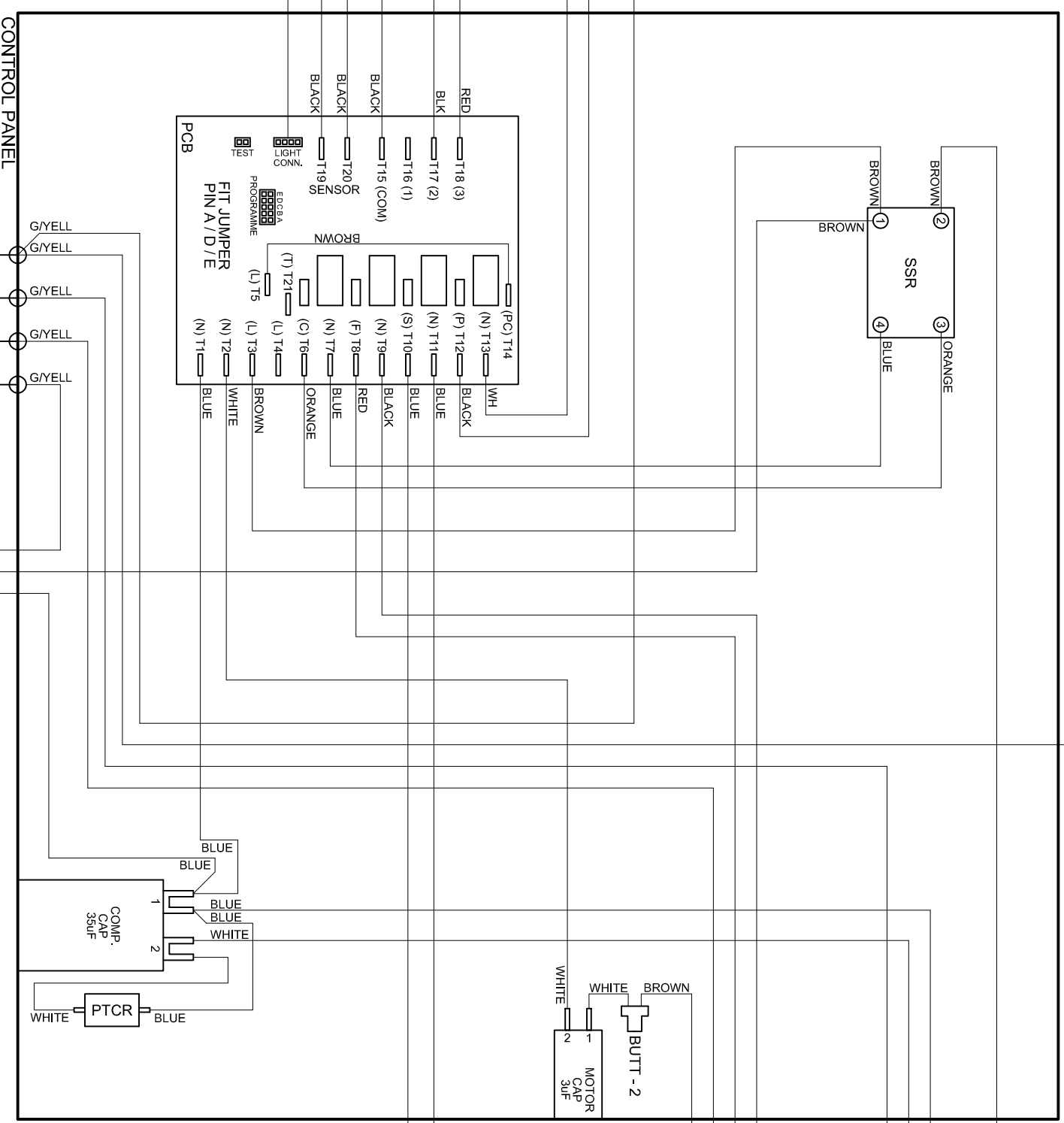
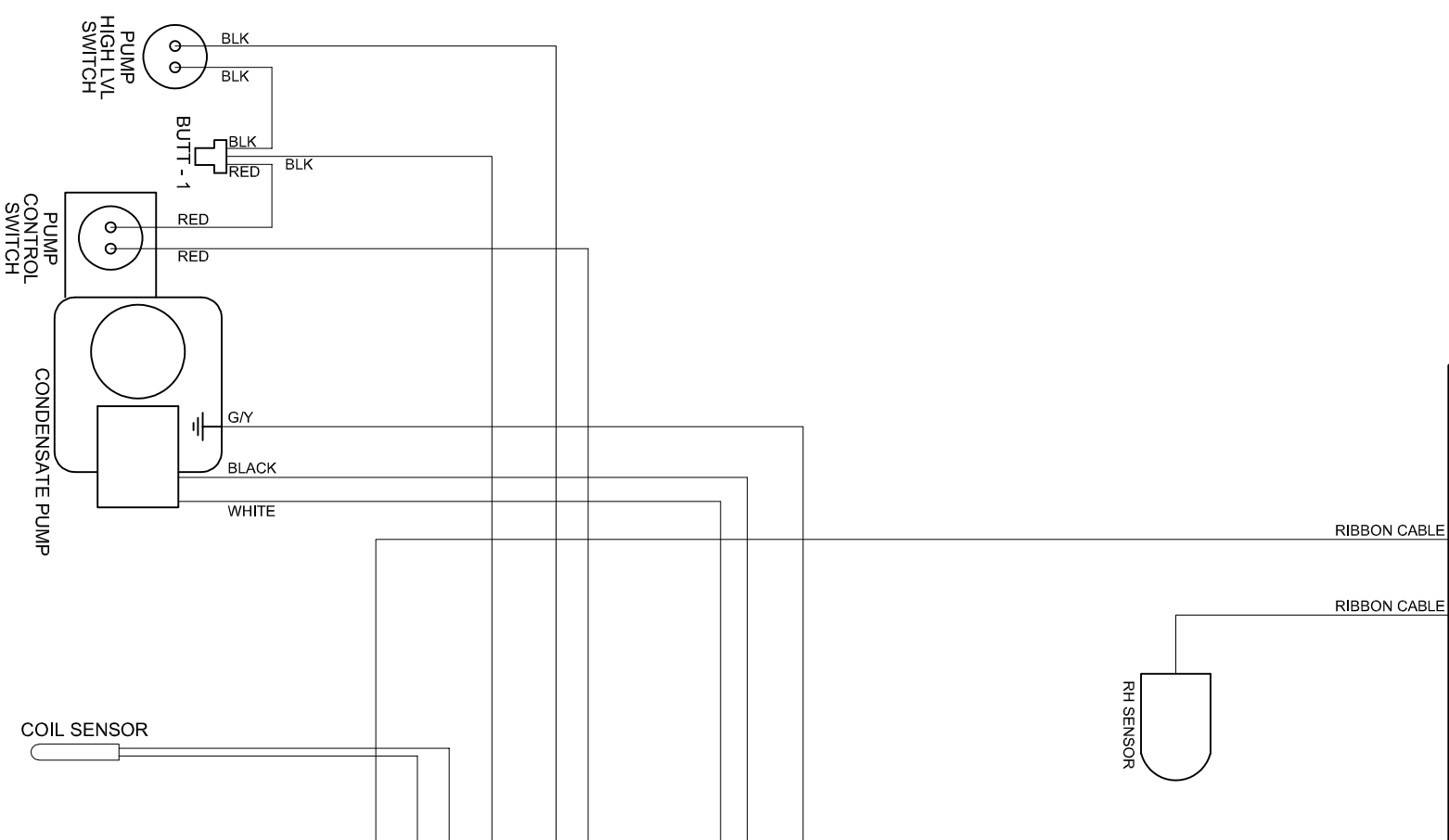
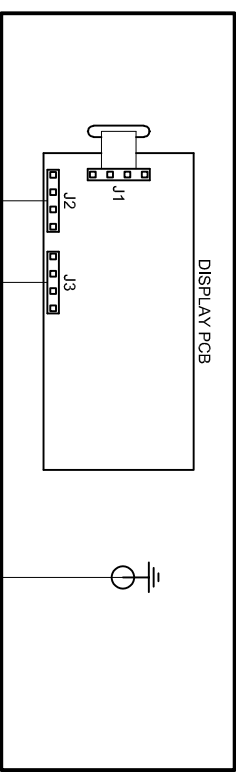

ISSUE	DATE	AMENDMENTS
1	08/08/23	ORIGINAL

BISHOP AUCKLAND  
 Co. DURHAM  
 ENGLAND

**3RD ANGLE PROJECTION**  
 DO NOT SCALE  
 IF IN DOUBT ASK

DIMENSIONS IN m.m.  
 TOLERANCES UNLESS  
 OTHERWISE STATED

0.	± 0.25
0.00	± 0.05
ANGULAR	± 0.5 DEGREE

**HM150-H (US - 110V) - WIRING DIAGRAM**

DRAWN: W DAGLISH  
 CAD SCALE: 1/1

FINISH: N/A  
 SHEET: 1 OF 1