

AD850E

DEHUMIDIFIER

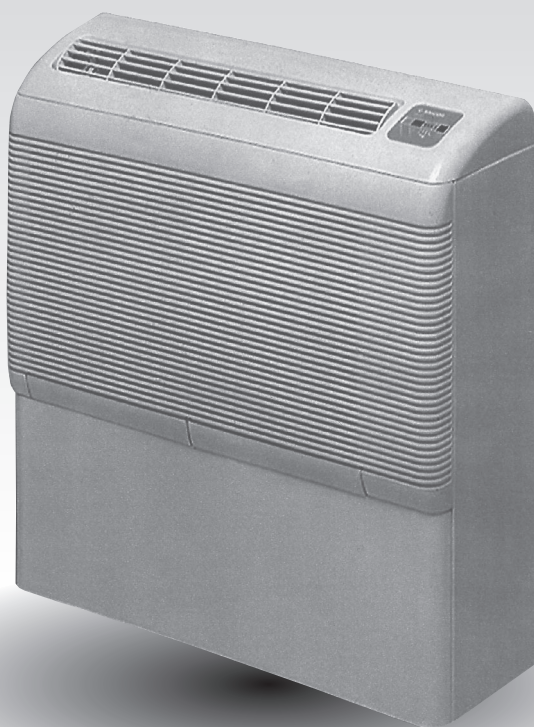

• **Instruction manual**





General safety

For safety reasons, read this manual carefully before operating. Persons who are not familiar with this manual must not use this dehumidifier. We strongly recommend keeping this manual in a safe place for future reference.

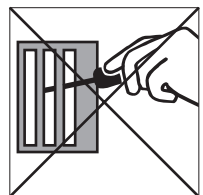
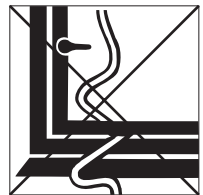
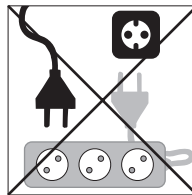
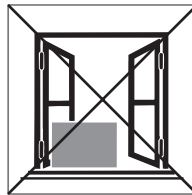
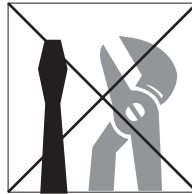
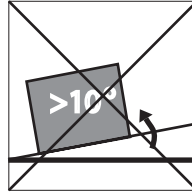

fig. 1

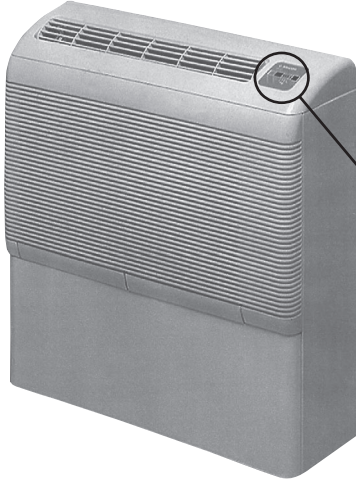

fig. 2

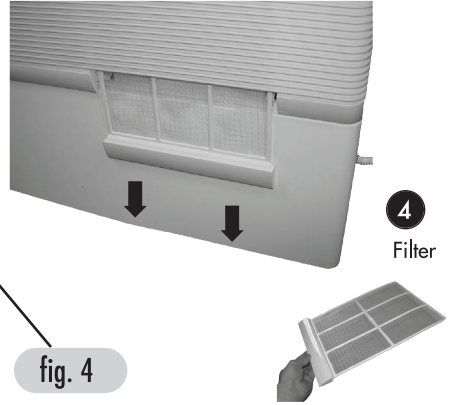

fig. 4

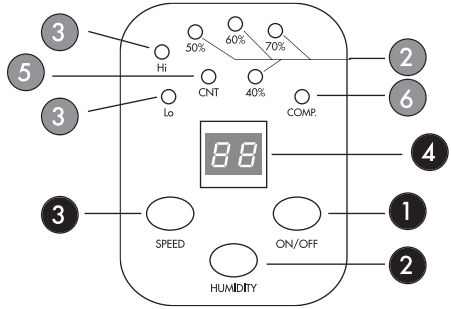

fig. 3

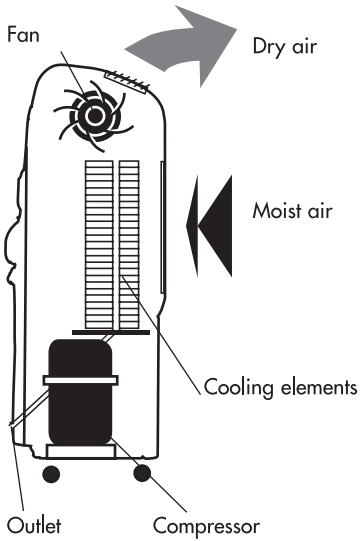
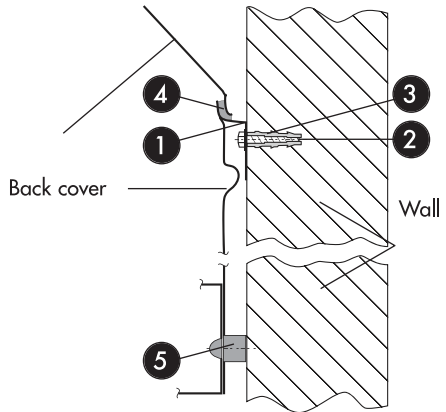

fig. 5





Instruction manual

It is important that you read these instructions before using your new dehumidifier and we strongly recommend keeping them in a safe place for future reference.

The first time that you use this dehumidifier please ensure that it has been standing for at least 2 hours in an upright position before it is switched on.

Thank you!

Thank you for choosing this innovative EIPL dehumidifier. The instruction manual describes the many benefits and advanced features that this unique product has to offer. The EIPL dehumidifier is a large capacity unit designed to run highly efficiently in places such as: restaurants, bars, printing presses, indoor swimming pools, jacuzzis, garages, animal enclosures, cellars, stores, boat sheds, weekend cottages, archives, etc.

EIPL has specialised in complete indoor environment control, manufacturing: dehumidifiers, portable air conditioners, coolers, air purifiers/ionisers and aromatherapy products. These world class products incorporate the latest technological developments and are designed to create a quality environment.

Safety

This appliance must be earthed and should only be connected to an earthed 115 V/60 Hz mains. The installation must be in accordance with the regulations of the country where the unit is used.

The unit is designated for indoor operation.

- The dehumidifier is safe. It has been approved by many safety institutions around the world. However, as with other electrical appliance, use it with care.
- Keep out of reach of children.
- Do not clean the dehumidifier by spraying it or immersing it in water.
- Do not insert any object into the opening of the dehumidifier.
- Disconnect from the mains before cleaning the unit or any of its components.
- Never connect to an electrical outlet using an extension cord. If an outlet is not available, one should be installed by a licenced electrician.
- Any service other than regular cleaning or filter replacement should be performed by an authorized service representative. Failure to do so could result in a loss of warranty.
- When the unit is placed in a (swimming) pool, connect to the mains via a transformer or a breaking switch, conform the regulations regarding electrical installations.

Your EIPL dehumidifier is supplied with an electrical cable and an earthed plug. Should it be necessary to replace this plug at any time, you must use an earthed electrical plug.



Warning Never operate this appliance if it has a damaged cord or plug.

If the supply cord is damaged, it must be replaced by an approved service representative or a similar qualified person in order to avoid any hazards.

There should be direct access to the electrical plug after connecting the power!

How it works

See page 3, fig. 3

Your EIPL dehumidifier controls the Relative Humidity by passing the air through the unit forcing the excess moisture to condensate over the cooling elements.

This condensate water then flows safely into a fixed drain.

The dried air then passes through a final heat exchanger where it is slightly warmed and re-enters the area at a slightly elevated temperature.

The level of dehumidifying is set with the humidistat control.

Positioning the dehumidifier

There must be free space of at least 30 cm between any other object and the front and the top of the unit.

Your EIPL dehumidifier can be installed in any area with a too high relative humidity, such as cellar, playing area, shed, archive or swimming pool.

The dehumidifier will begin to protect from the harmful effects of excess moisture as soon as it is plugged in and switched on.

When positioning your EIPL dehumidifier, ensure that it is placed on a level surface.

Wall mounting

See page 3, fig. 5

The unit can stand on the floor or hung on a wall. All necessary items for wall mounting are supplied in the plastic bag.

Fix the supporting bracket with at least 5 screws horizontally to the wall, use the plugs for better fastening.

Best results are obtained when windows and doors are closed, thus preventing the possible influx of fresh, too humid, air.

When the unit is placed in a (swimming) pool, connect to the mains via a transformer or a breaking switch, conform the local regulations regarding electrical installations.

When the dehumidifier is in operation, open outside doors and windows only when necessary.

Hang the unit on the bracket, the two tongues fit into the slots on the unit's rear panel.

Make sure the two rubber pads (3) on the tongues and the two rubber supports (4) on the lower part of the rear panel are properly placed.

Drainage

There are four optional outlets for the drainage tube. To change the outlet of the drainage tube the rear panel should be dismantled. When remounting the rear panel care should be taken to return all the screws and washers to their original location.

Connecting the permanent outlet

- Connect the pipe to an outlet tube with the correct diameter.
- Push the other end of the tube into a drain, making sure that the tubing cannot be twisted or folded.
- Ensure that the outlet of the drainage pipe is NOT under the water level in the drain.

The AD850E dehumidifier is fitted with a self contained, fully automatic, internal condensate pump and associated water reservoir. This pump is capable of pumping the condensate to a maximum height of 4.3m. The short length of tubing maybe extended using the two part “Quick Disconnect” coupling and the additional length of tubing provided with the unit. No additional user operation is required.

NOTE: In very cold weather conditions precautions should be taken to prevent the drainage pipe from freezing.

Controls

See page 3, fig. 4

ON/OFF (1)

The unit is switched on and off by pressing the ON/OFF button (1). When the unit is on, the fan runs in the set speed.

Humidity (2)

Press the HUMIDITY button (2) repeatedly to choose the desired level of relative humidity in the area. The corresponding control lights (2) will indicate the selected percentage. The yellow CNT control light (5) indicates that the unit is running continuously, disregarding the relative humidity level in the area.

Ventilator speed (3)

Press the SPEED button (3) to select low or high speed. The corresponding control light (3) will indicate this, Lo=low or Hi=high.

Digital display (4)

The digital display (4) will show the measured relative humidity in the area.

Compressor (6)

The COMP control light (6) will be on when the compressor is running. An automatic time delay of five minutes before the compressor can (re-)start working is a safeguard against damage.

IMPORTANT:

This dehumidifier should not be used in temperatures below 45 °F or above 95 °F.

Defrost Control

The dehumidifier is equipped with an automatic de-icing mode to defrost the refrigeration coil during low temperature operation. The compressor is switched off whilst the ventilator continues to run.

Cleaning

Disconnect from the mains before cleaning the unit or any of its components.

See page 3, fig. 2

Cleaning the air filter

Air circulation is impeded and the efficiency of the dehumidifying and air purifying functions decreases when the filter is dirty. It is therefore good practice to clean the filter at regular intervals. The precise intervals depend on the room in which the appliance operates and on how frequently it is used.

- Remove the filter (4) by sliding it out.
- Clean the filter or wash in tap water. Cleaning the air filter
- Dry the filter before inserting it back.

Housing

Wipe regularly clean with a moist cloth and mild household detergent.

Servicing

Have your dehumidifier once a year serviced by a qualified engineer.

Trouble-shooting

If the dehumidifier does not operate:

- Make sure the unit is plugged in.
- Ensure the humidistat control is turned on.

If the unit is noisy:

- Make sure the dehumidifier is standing solidly and level.

If the unit is leaking:

- Check the drainage tube for correct fitting.
- Check for twists and bends in the drainage tube.
- Check and make sure that the outlet of the drainage pipe is not under the water-level in the drain.

Technical data

Model	AD850E	Dimensions	width	660 mm
Mains	115 V/60 Hz		height	750 mm
Airflow	500 m ³ /h		depth	345 mm
Power consumption	880 W (at high fan speed)	Water extraction		45 L/24h
Current (operation)	7.9 A	(at 86 °F, 70% RH)		
Operating temperature	45 °F to 95 °F	Refrigerating agent		R410a
Current (at start)	32 A	Weight (net)		39 kg

Meets UL STD 474 Regulation.

Specifications may change without prior notice.

for reference purposes only

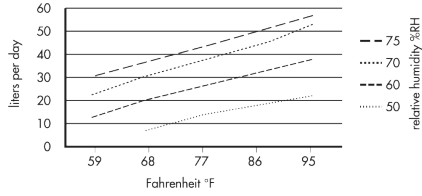

Moisture removal

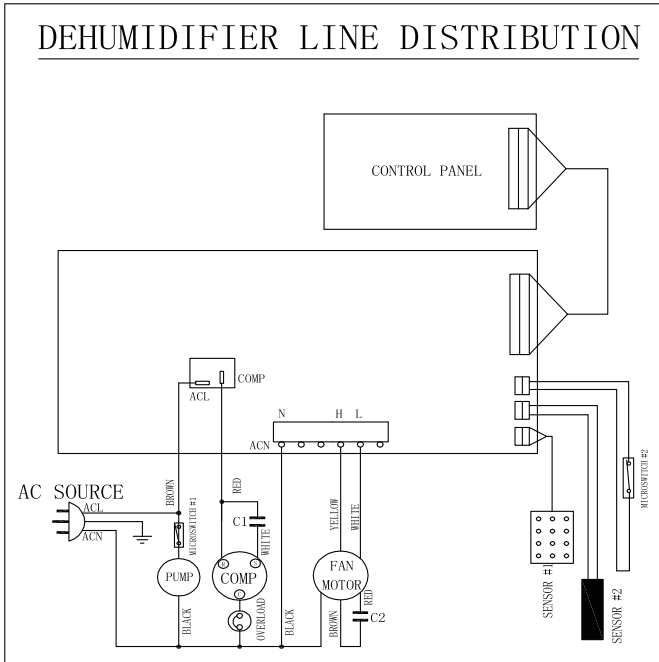

Sales & Support Offices

Ebac Industrial Products Ltd
 ST Helens Trading Estate
 Bishop Auckland
 Co. Durham
 DL14 9AD

Tel: +44 1388 664400
 Fax: +44 1388 662590

Ebac Industrial Products Inc
 700 Thimble Shoals Blvd
 Suite 109
 Newport News
 VA, 23606-2575

Tel: +1 757 873 6800
 Fax: +1 757 873 2632

